

QSD9004 Motion Email Setup

Prior to setting up motion email, be sure that your DVR has the latest firmware and that it is set up for Network access. It is also recommended that you use Gmail as your email contact due to its reliability; however, you may use other email services.

STEP 1: Press the Menu button on the Front Panel of the DVR.

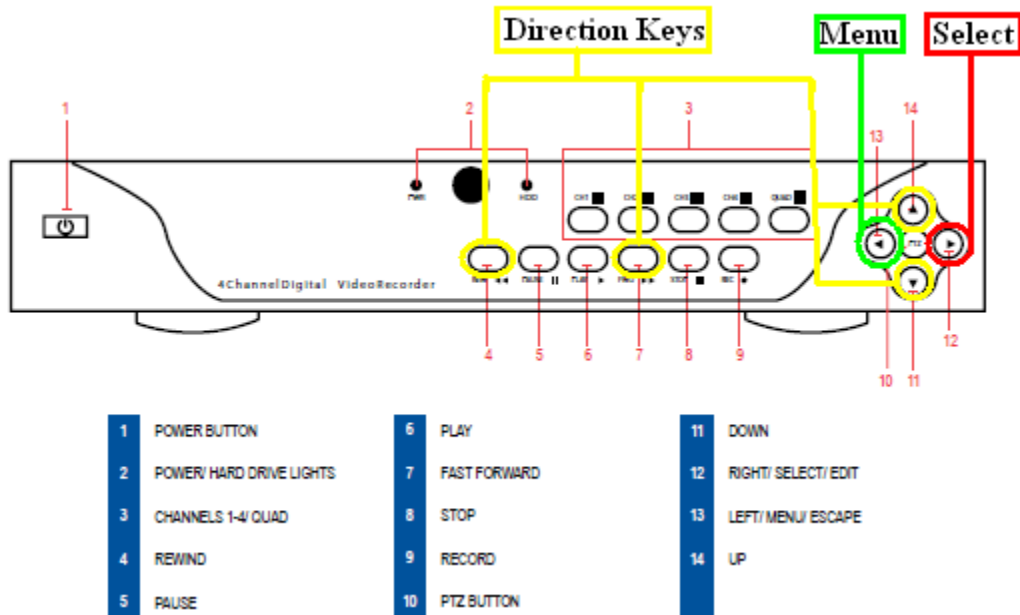

STEP 2: Move cursor to “RECORD” press the “Select” button on the front panel of the DVR. (Note: Steps 2 through 19 are for setting up Motion Detection, a prerequisite for setting up motion email. If your DVR is already set up for motion detection, skip to STEP 20)



QSD9004 Motion Email Setup

STEP 3: Set which channels you want to record (switch to “ON”).

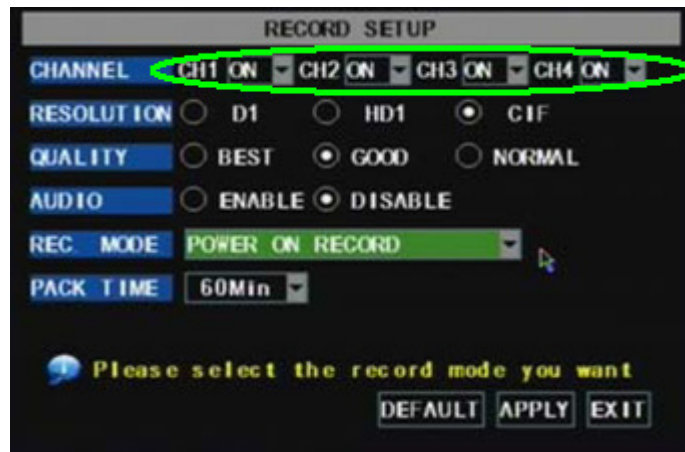

STEP 4: Set the pack time; this will determine how long each recorded file will be.



STEP 5: Set Rec. Mode to “TIME SCHEDULE RECORD”.

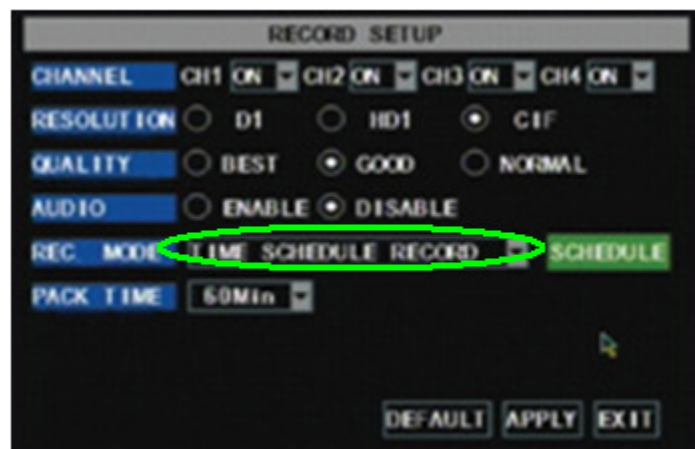

QSD9004 Motion Email Setup

STEP 6: Move the cursor to “SCHEDULE” and press “Select”.



STEP 7: Set which channels you want to schedule under “CHANNEL”.

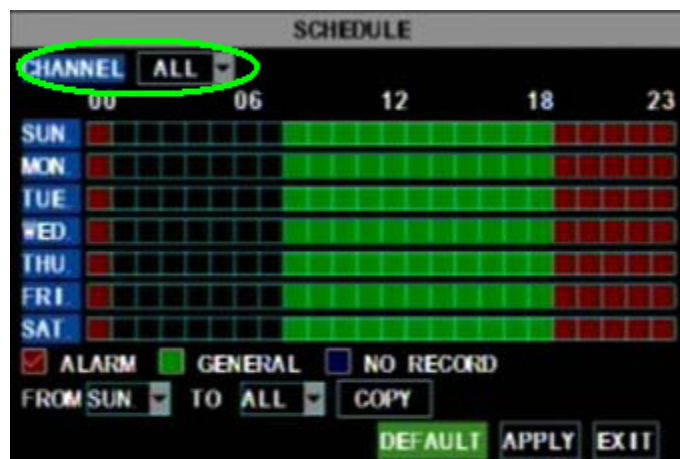

STEP 8: Put a checkmark in the box next “ALARM”.

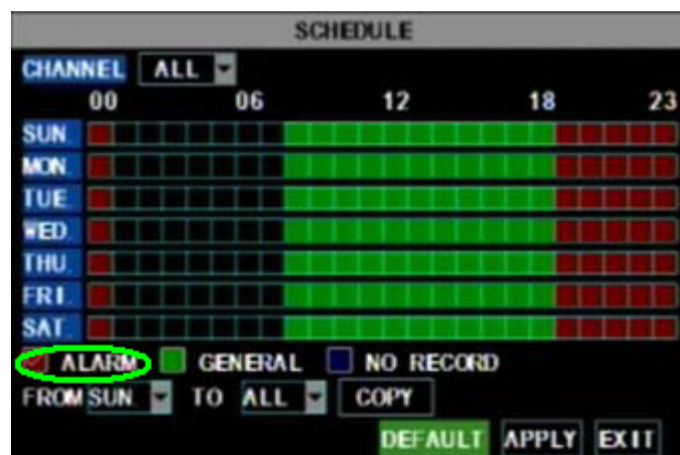

QSD9004 Motion Email Setup

STEP 9: Select the desired dates and times that you want to schedule recording for.

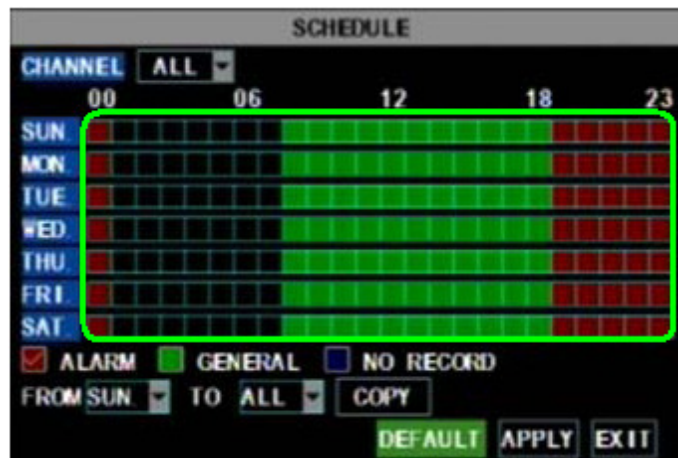

STEP 10: Once you have set your schedule, move the cursor to “APPLY” and press “Select”.



STEP 11: Move cursor to “APPLY” and press “Select”.



QSD9004 Motion Email Setup

STEP 12: Move cursor to “DEVICES” and press “Select”.



STEP 13: Move cursor to “MOTION” and press “Select”.



STEP 14: Set which channels you want to enable motion detection for (switch to “ON”).

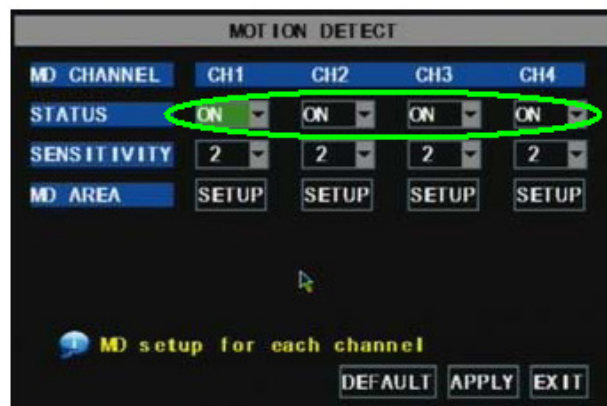

QSD9004 Motion Email Setup

STEP 15: Set the sensitivity level for triggering motion detection.

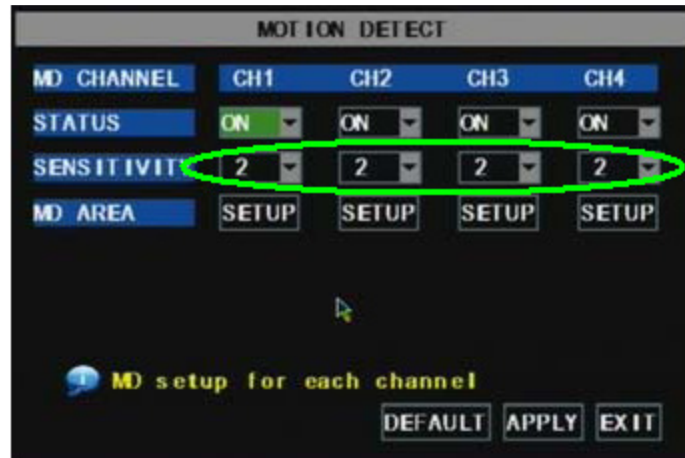

STEP 16: Move the cursor to “SETUP” and press “Select”.



STEP 17: Using the direction keys and the “Select” button, you can set the motion detection area. The area that is red is sensitive to motion.

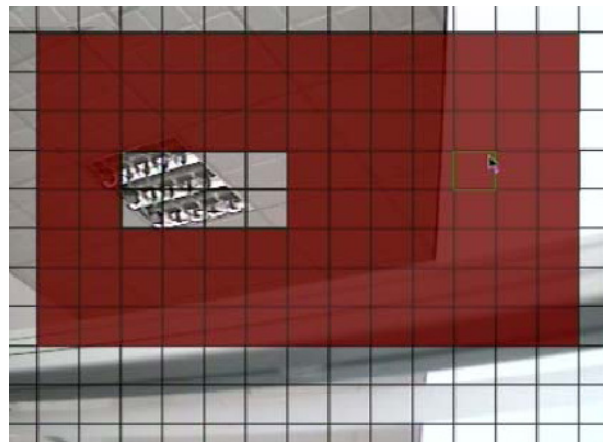

QSD9004 Motion Email Setup

STEP 18: Move the cursor to “APPLY” and press “Select”.



STEP 19: Move the cursor to “EXIT” and press “Select”.



STEP 20: Move the cursor to “DEVICES” and press Select.



QSD9004 Motion Email Setup

STEP 21: Move the cursor to “ALARM” and press Select.



STEP 22: Move the cursor to “EMAIL SETUP” and press Select.



STEP 23: Set the email setting from “off” to “on”.

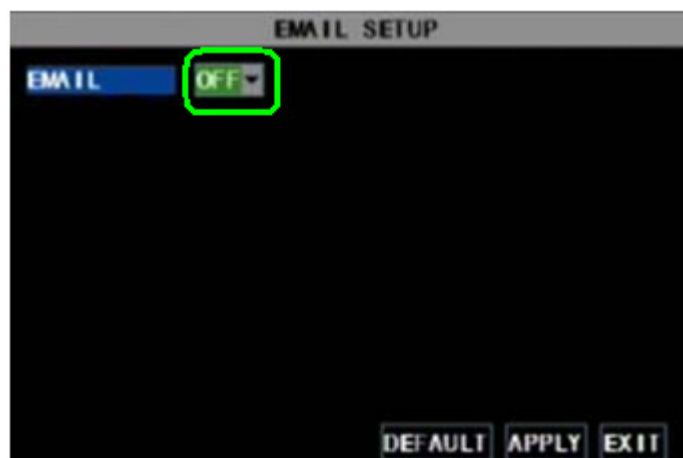

QSD9004 Motion Email Setup

STEP 24: Set SSL to “ON” if you are using Gmail; otherwise, set SSL to “OFF”.

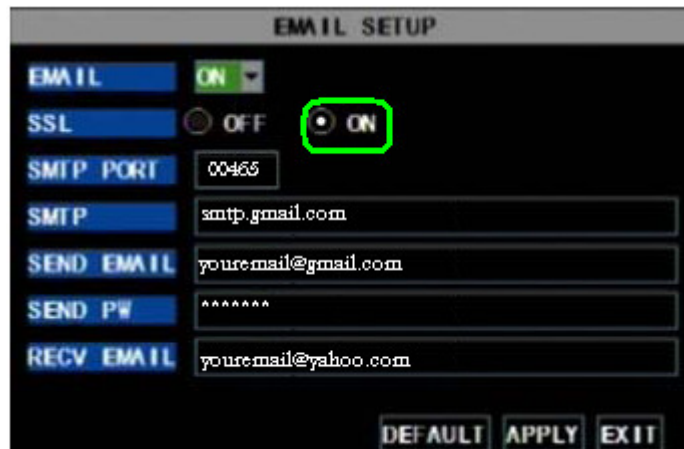

The screenshot shows the 'EMAIL SETUP' menu. The 'EMAIL' status is 'ON'. The 'SSL' option has two radio buttons: 'OFF' and 'ON'. The 'ON' radio button is selected and circled in green. Other fields include 'SMTP PORT' (00465), 'SMTP' (smtp.gmail.com), 'SEND EMAIL' (youremail@gmail.com), 'SEND PW' (*****), and 'RECV EMAIL' (youremail@yahoo.com). Buttons for 'DEFAULT', 'APPLY', and 'EXIT' are at the bottom.

STEP 25: Set SMTP Port to “00465” if you are using Gmail; otherwise set SMTP Port to “00025”.

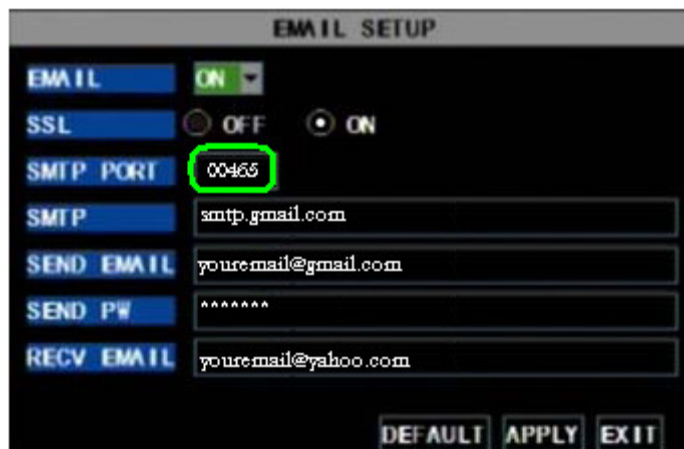

The screenshot shows the 'EMAIL SETUP' menu. The 'EMAIL' status is 'ON'. The 'SSL' option has two radio buttons: 'OFF' and 'ON'. The 'SMTP PORT' field is highlighted with a green circle and contains the value '00465'. Other fields include 'SMTP' (smtp.gmail.com), 'SEND EMAIL' (youremail@gmail.com), 'SEND PW' (*****), and 'RECV EMAIL' (youremail@yahoo.com). Buttons for 'DEFAULT', 'APPLY', and 'EXIT' are at the bottom.

STEP 26: Under “SMTP” enter the server address of the email service that you use.

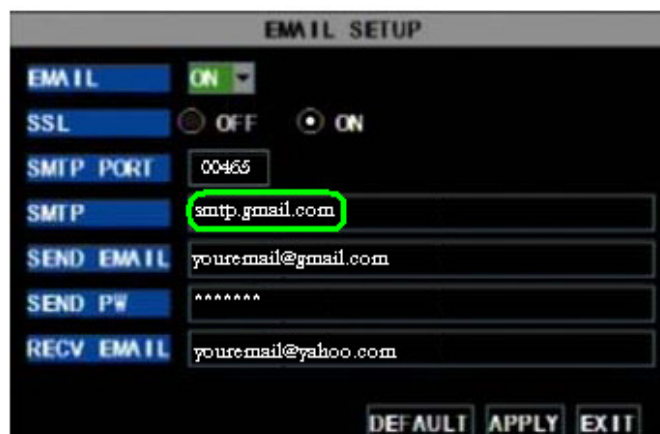

The screenshot shows the 'EMAIL SETUP' menu. The 'EMAIL' status is 'ON'. The 'SSL' option has two radio buttons: 'OFF' and 'ON'. The 'SMTP' field is highlighted with a green circle and contains the value 'smtp.gmail.com'. Other fields include 'SMTP PORT' (00465), 'SEND EMAIL' (youremail@gmail.com), 'SEND PW' (*****), and 'RECV EMAIL' (youremail@yahoo.com). Buttons for 'DEFAULT', 'APPLY', and 'EXIT' are at the bottom.

QSD9004 Motion Email Setup

STEP 27: Under “Send Email”, enter your email address.

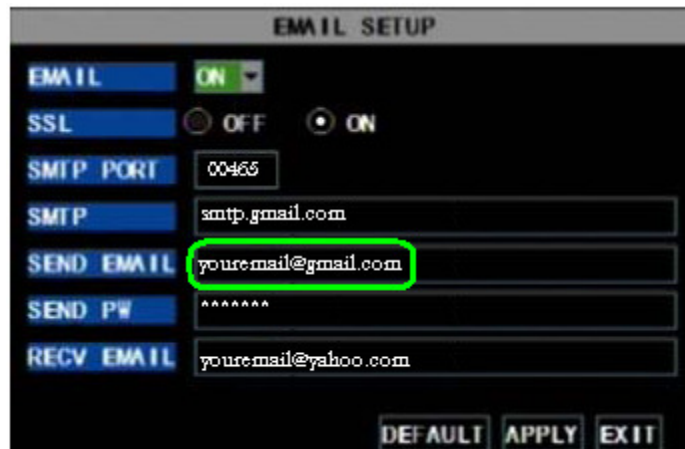

The screenshot shows the 'EMAIL SETUP' menu with the following fields and values:

Field	Value
EMAIL	ON
SSL	OFF
SMTP PORT	00465
SMTP	smtp.gmail.com
SEND EMAIL	youre-mail@gmail.com
SEND PW	*****
RCV EMAIL	youre-mail@yahoo.com

Buttons at the bottom: DEFAULT, APPLY, EXIT

STEP 28: Under “Send PW”, enter your email’s password.

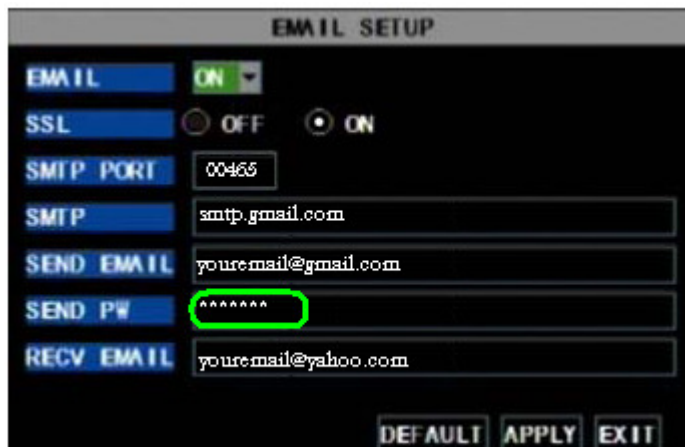

The screenshot shows the 'EMAIL SETUP' menu with the following fields and values:

Field	Value
EMAIL	ON
SSL	OFF
SMTP PORT	00465
SMTP	smtp.gmail.com
SEND EMAIL	youre-mail@gmail.com
SEND PW	*****
RCV EMAIL	youre-mail@yahoo.com

Buttons at the bottom: DEFAULT, APPLY, EXIT

STEP 29: Under “Recv Email”, enter a secondary email address.

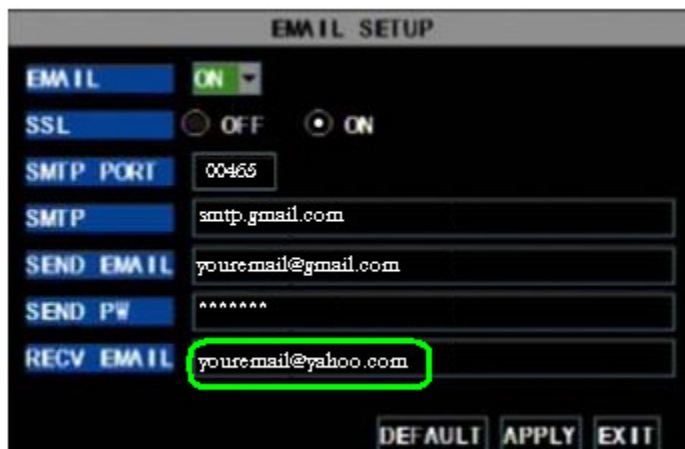

The screenshot shows the 'EMAIL SETUP' menu with the following fields and values:

Field	Value
EMAIL	ON
SSL	OFF
SMTP PORT	00465
SMTP	smtp.gmail.com
SEND EMAIL	youre-mail@gmail.com
SEND PW	*****
RCV EMAIL	youre-mail@yahoo.com

Buttons at the bottom: DEFAULT, APPLY, EXIT

QSD9004 Motion Email Setup

STEP 30: Move the cursor to “APPLY” and press Select.

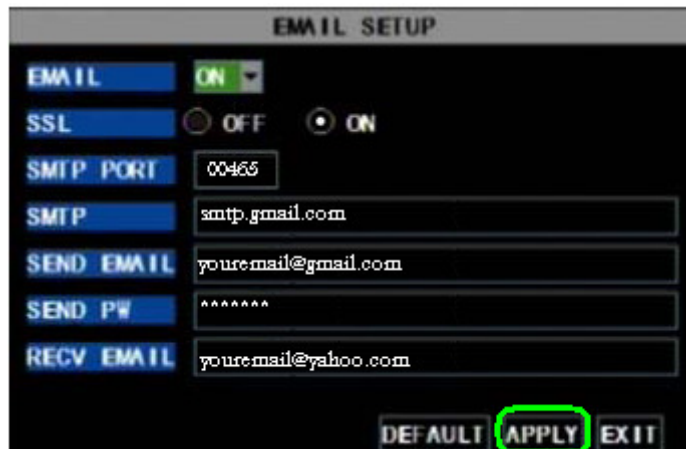

STEP 31: Move the cursor to “Network” and press Select.

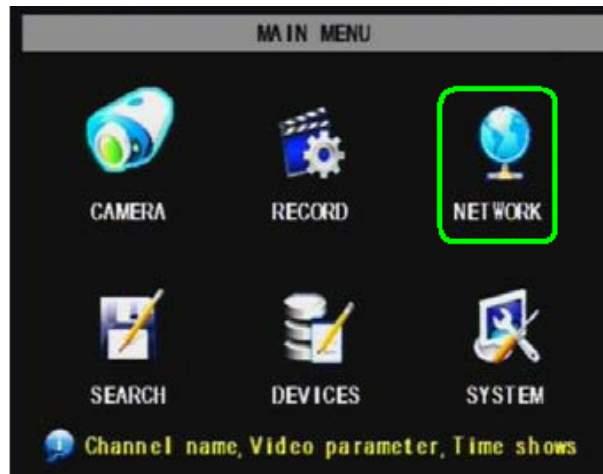

STEP 32: Under “DNS”, input the domain name server. This can be found under the status tab when you log in to your router.

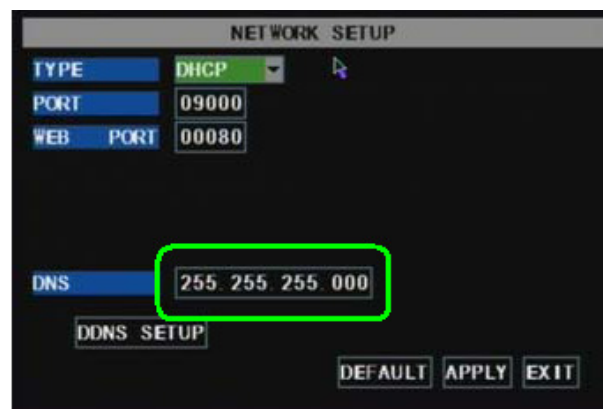

QSD9004 Motion Email Setup

STEP 33: Move the cursor to “APPLY” and press Select.

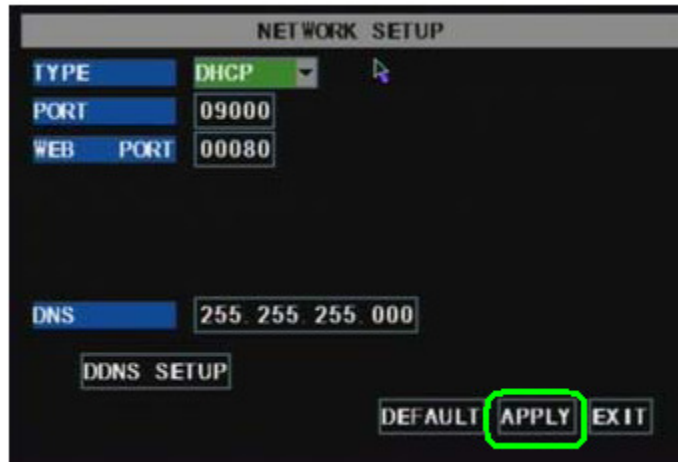

The screenshot shows a network configuration menu titled "NETWORK SETUP". The menu items and their values are as follows:

Field	Value
TYPE	DHCP
PORT	09000
WEB PORT	00080
DNS	255 255 255 000

At the bottom of the screen, there are three buttons: "DDNS SETUP", "DEFAULT", and "APPLY". The "APPLY" button is highlighted with a green circle. The "EXIT" button is also visible to the right of "APPLY".