

# QSD9004 Activating and Changing Passwords

**STEP 1:** Press the Menu button on the Front Panel of the DVR

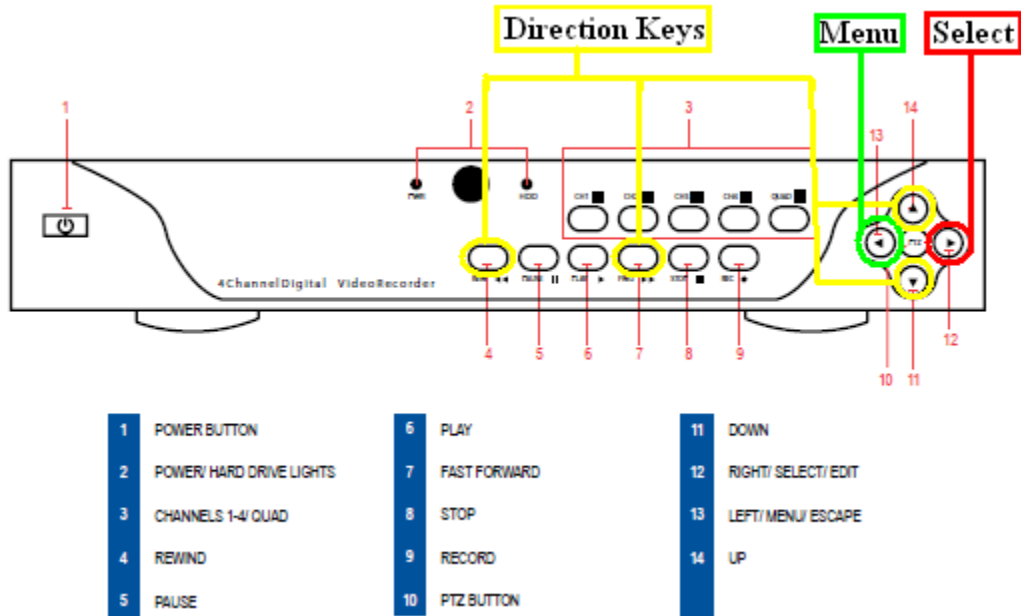

**STEP 2:** Move cursor to “SYSTEM” press the “Select” button on the front panel of the DVR.



## QSD9004 Activating and Changing Passwords

**STEP 3:** Move the cursor to “PASSWORD” and press “Select”.



**STEP 4:** Move the cursor to the box next to “PASSWORD ENABLE” and switch the contents from “OFF” to “ON”.

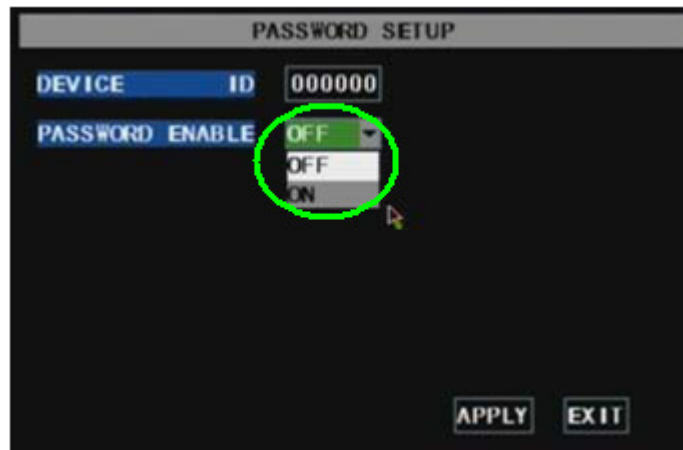

## QSD9004 Activating and Changing Passwords

**STEP 5:** Move the cursor to the box next to “USER PASSWORD” and press “Select”. Input a numerical password.

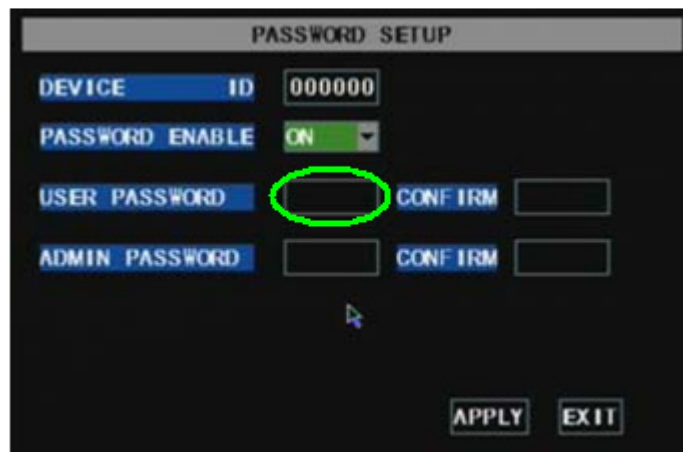

The screenshot shows the "PASSWORD SETUP" menu. The fields are as follows:

Field	Value
DEVICE ID	000000
PASSWORD ENABLE	ON
USER PASSWORD	[Empty box, highlighted with a green circle]
CONFIRM	[Empty box]
ADMIN PASSWORD	[Empty box]
CONFIRM	[Empty box]

Buttons: APPLY, EXIT

**STEP 6:** Move the cursor to the box next to “CONFIRM” and press “Select”. Input the same numerical password that you entered in the last step.

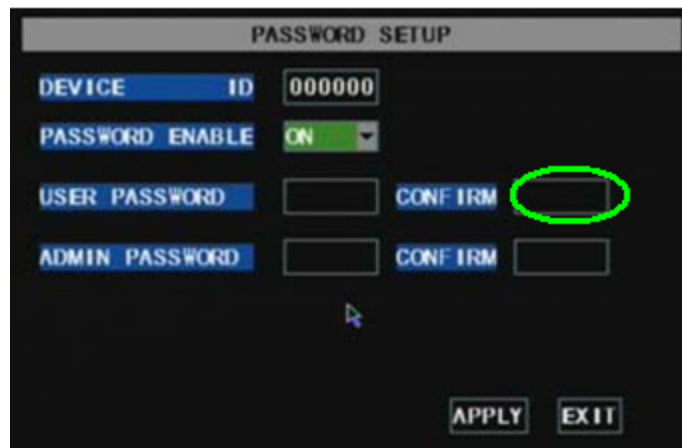

The screenshot shows the "PASSWORD SETUP" menu. The fields are as follows:

Field	Value
DEVICE ID	000000
PASSWORD ENABLE	ON
USER PASSWORD	[Empty box]
CONFIRM	[Empty box, highlighted with a green circle]
ADMIN PASSWORD	[Empty box]
CONFIRM	[Empty box]

Buttons: APPLY, EXIT

## QSD9004 Activating and Changing Passwords

**STEP 7:** Move the cursor to the box next to “ADMIN PASSWORD” and press “Select”. Input a numerical password.

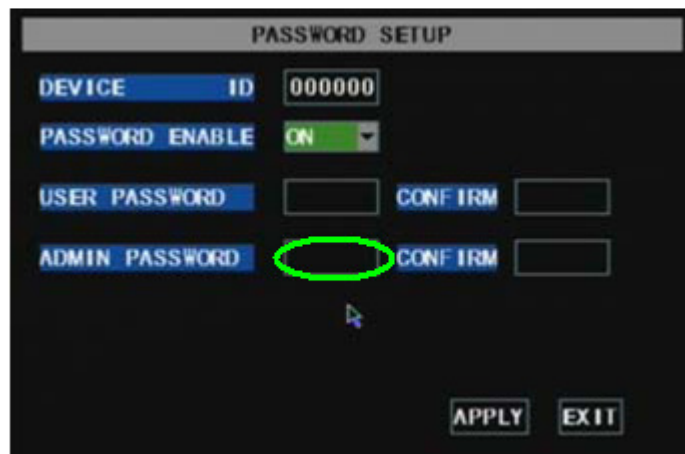

The screenshot shows a terminal window titled "PASSWORD SETUP". It contains the following fields and options:

- DEVICE ID: 000000
- PASSWORD ENABLE: ON (dropdown menu)
- USER PASSWORD: [ ] CONFIRM: [ ]
- ADMIN PASSWORD: [ ] CONFIRM: [ ]

The "ADMIN PASSWORD" input field is highlighted with a red oval. At the bottom right, there are "APPLY" and "EXIT" buttons.

**STEP 8:** Move the cursor to the box next to “CONFIRM” and press “Select”. Input the same numerical password that you entered in the last step.

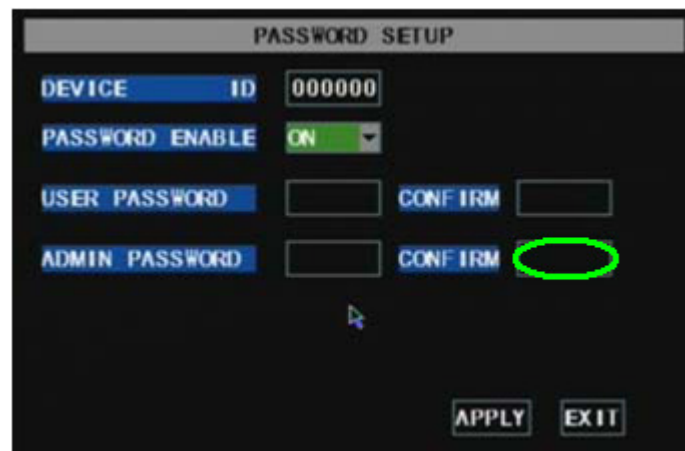

The screenshot shows the same "PASSWORD SETUP" terminal window. In this step, the "CONFIRM" input field for the "ADMIN PASSWORD" row is highlighted with a red oval. The "ADMIN PASSWORD" field itself is now empty. The "APPLY" and "EXIT" buttons remain at the bottom right.

## QSD9004 Activating and Changing Passwords

**STEP 9:** Move the cursor to “APPLY” and press “Select”.



The screenshot shows the 'PASSWORD SETUP' menu. The 'DEVICE ID' is set to '000000'. 'PASSWORD ENABLE' is set to 'ON'. There are two rows for password entry: 'USER PASSWORD' and 'ADMIN PASSWORD', each with a 'CONFIRM' field. The 'APPLY' button at the bottom right is circled in green, indicating it is the next step.

Field	Value
DEVICE ID	000000
PASSWORD ENABLE	ON
USER PASSWORD	
CONFIRM	
ADMIN PASSWORD	
CONFIRM	

To change password, repeat steps 1-3 and change the password fields as shown below.

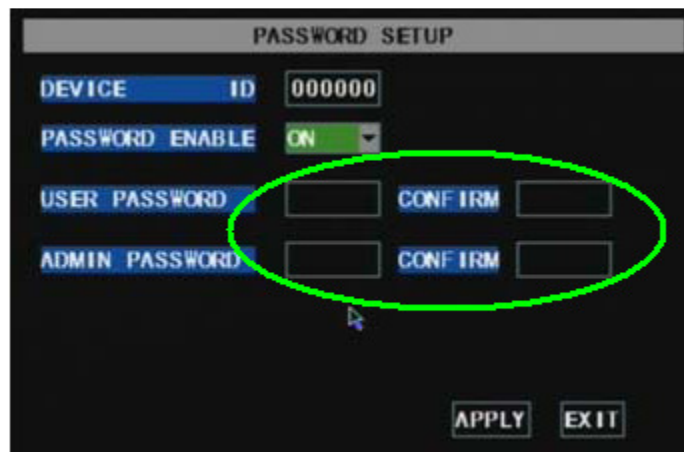

The screenshot shows the 'PASSWORD SETUP' menu. The 'DEVICE ID' is set to '000000'. 'PASSWORD ENABLE' is set to 'ON'. The 'USER PASSWORD' and 'ADMIN PASSWORD' fields, along with their respective 'CONFIRM' fields, are circled in green, indicating they are the next step for modification.

Field	Value
DEVICE ID	000000
PASSWORD ENABLE	ON
USER PASSWORD	
CONFIRM	
ADMIN PASSWORD	
CONFIRM	